

GTR-AR

AR Series

Z-Type Reducer(servomotor model)

Low Backlash Type

High Accuracy Type

Instruction Manual

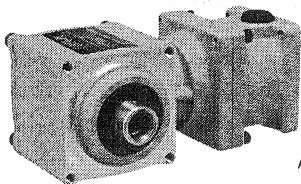

AFC

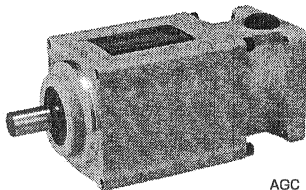

AGC

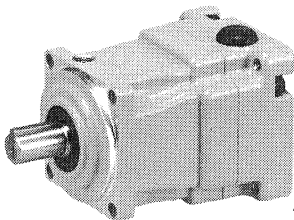

APG



Introduction

Thank you for your purchasing the **GTR-A** A-Series.
Before operation, please read this "Instruction Manual"
for proper operation of this product.

The contents of this Manual are subject to change without any notice.

Caution for Safety

- The reducer should be operated by a skilled and qualified person. And the content of this Instruction Manual should be carefully read and understood before operating this product.
- This Instruction Manual should be delivered to a person who actually operates this product.
- This Instruction Manual should be kept in order for operator to always use, before operation.
- In this Manual, injuries and damages anticipated in case of mishandling of the equipment, are basically classified into two categories, "Danger" and "Caution". The definition of the classification are given below with the corresponding graphic symbols.

 Danger	Mishandling of the equipment may result in dangerous situation and may lead to serious or fatal injury to personnel
 Caution	Mishandling of the equipment may result in dangerous situation and may lead to medium to light injury, or may result in damage to the equipment.

Please be aware that even items marked with "CAUTION" may cause fatal accidents. Therefore, be sure to follow the instruction, for every item described is very important.

Danger

(General)

- Be sure to use an explosion-proof motor in the circumstances where any explosive or flammable gases exist. Failure to observe this warning may cause explosion, spark, fire, electric shock, physical injury, and/or damage to the equipment.
- The operators in charge of transportation, installation, wiring, operation, handling, maintenance, and inspection of the equipment should have enough knowledge and technical skill for the product. Failure to observe this warning may cause explosion, spark, fire, electric shock, physical injury and/or damage to the equipment.
- If the equipment is to be used in a system for human transport, be sure to furnish it with a protective device for safety. Failure to this warning may cause personal injury, and/or damage to the equipment.
- If the equipment is to be used with an elevator, be sure to furnish it with a safety device to prevent the elevator from accidental falling. Failure to observe this warning may cause personal injury and/or damage to the equipment.

(Transportation)

- When a product is lifted up for transportation, be sure not to enter underneath of the lifted product. Falling of product may cause serious injury.

(Operation)

- Do not approach or touch rotating parts such as a shaft while the machine is running. Failure to observe this warning may cause drag-in and physical injury.

(Daily inspection, Maintenance)

- In case of maintenance or inspection during operation, do not approach or touch rotating parts such as a shaft. Failure to observe this warning may cause wind-in and physical injury.
- When inspecting the condition of gears at down time, be sure to lock up the drive and driven unit beforehand. Failure to observe this warning may cause wind-in and physical injury.
- In case of getting into closed equipment to inspect its condition, be sure to lock up the drive and driven units and confirm whether the equipment is sufficiently cooled down beforehand. Also, keep on ventilating while inspecting inside. Furthermore, another person should stay outside to watch the safety conditions and keep in touch with the one inside during inspection. It can be very slippery with lubricant around the driven equipment, so special attention should be given to safety. Failure to observe this warning may cause physical injury.
- Do not operate the equipment with the safe guard off for inspection. Failure to observe this warning may cause draw-in and physical injury.

Caution

(General)

- Do not use the product under conditions other than specified in the nameplate of the reducer or the product specifications. Failure to observe this warning may cause physical injury and/or damage to the equipment.
- Do not insert your fingers or any other object into the aperture of the reducer. Failure to observe this warning may result in physical injury and/or damage to the equipment.
- Do not use the damaged reducer. Failure to observe this warning may result in physical injury.
- Do not take off the nameplate.
- The manufacturer will not warrant and will not be responsible for the product modified or repaired by the user himself.

(Inspection upon Arrival Of Products)

- Check whether the product is the same product as ordered. Installing a wrong product may cause physical injury and/or damage to the equipment.

(Installation)

- Do not place any object inflammable near the reducer. Failure to observe this warning may cause fire.
- Do not place any object which may interfere with the ventilation around the reducer. Failure to observe this warning may result in abnormal overheating caused by the block off of the cool air, which may cause burn injury and/or fire.
- Do not step on an reducer or hang to it. Failure to observe this warning may cause physical injury.
- Do not touch the edge of the shaft of reducer or key groove in the bore with bare hands. Failure to observe this warning may cause physical injury.
- In equipments like food machines, which must avoid oil or grease, furnish with protective devices like oil pan, in order to protect from the oil leakage caused by failures or life of the manufactured products. Leaking oil may cause defective products.
- Do not give any shock to the reducer like hitting by hammer. Failure to observe this warning may cause machine trouble.
- Vibrations from the installation surface of the reducer or from the other source should be minimized at less than 0.5G.

(Connecting with Other Equipment)

- When connecting the reducer with a load, make sure of the alignment of shafts, the tension of belts and parallelism of pulleys. In direct coupling, be sure to check whether the alignment of shaft is extremely precise. If a belt is to be used, be sure to adjust its tension properly. Also, before operation, inspect whether the setting bolts for pulleys and coupling are securely tightened. Failure to observe this warning may cause serious injury and/or damage to the equipment due to broken parts.
- Safe guard should be furnished around rotating parts to avoid danger to persons.
- Before coupling with the other machine, be sure to check the direction of rotation. Unexpected operation in wrong direction may cause serious injury and/or damage to the equipment.

(Operation)

- During operation, the reducer becomes rather hot, therefore do not touch it with bare hands or with body.
- Failure to observe this warning may cause burn injury.
- When a reducer is found abnormal, stop it immediately. Failure to observe this warning may cause physical injury and/or fire.
- When a motor is to be reversed, be sure to start reversing after complete stop of the motor. Otherwise, the equipment may be broken caused by the reverse running by plugging.
- Be sure to use the reducer under the position that the inertial load at the output shaft side will never vibrate when accelerating or decelerating.
- The surface temperature of the reducer should not exceed 90°. In case the temperature goes over than 90°, make it less than 90° by cooling with an external fan or a heat sink.

(Daily inspection and maintenance)

- Surface of a reducer becomes extremely hot, therefore, do not touch it with bare hands. Failure to observe this warning may cause burn injury.
- When operation is found abnormal, diagnose the fault according to the instruction manual. Be sure not to run the machine until the cause of the trouble is cleared and proper measure is taken.

(Disassemble and Assemble)

- Be sure to ask our branch office or factory for repairing, disassembling and assembling equipment. Failure to observe this warning may cause physical injury or fire.
- Reducer and its lubricant should be disposed as industrial waste.

Contents

Introduction Cautions for Safety Contents

1 Before Operation	6
1-1 Parts Names	
1-2 Check and Verification Before Operation	
2 Assembly and Installation	
2-1 Assembly of Servomotor	7
2-2 Installation of Reducer	8
a) Proper Environment for Installation	
b) Installation Method	
c) Mounting Position	
d) Connecting with Other Equipment	
3 Rigidity	10
4 Maintenance and Product Life	10
5 Warranty	11

1 Before Operation

1-1 Parts Names

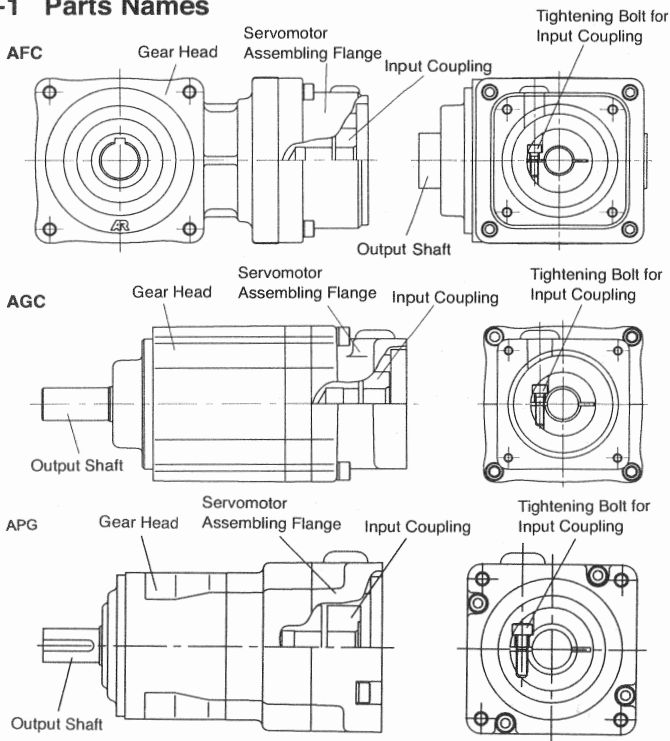

1-2 Check and Verification Before Operation

When unpacking a carton, please check up if:

- (1) The ordered products and the contents indicated in the nameplate are correct.
- (2) No damage to the product during transportation exist.
- (3) Screws or nuts are not loose.
- (4) Contents of the package:
 - a) Reducer 1 unit
 - b) Instruction Manual(this booklet) 1 copy
 - c) Optional accessories

If you have any problems or questions, please do not hesitate to contact the dealer from which the product was supplied or our local office.

2 Assembly and Installation

2-1 Assembly of Servomotor

Assembling Procedure

1. Rotate the input coupling to adjust the position of the bolt head of the coupling to the wrench hole.
2. Wipe oil or rust preventives etc. on the input coupling part and output shaft of the servomotor.
3. Insert the output shaft of the servomotor into the coupling.
※ In case of bushing-type, please make sure that both coupling's and bush's gaps are on the same position.(See Fig.1 below)
Moreover, if the servomotor's output shaft has a keyway, it should be on the same position as well.(See Fig.2 below)
4. Tighten the bolt with the designated torque to connect the flange of the servomotor and the reducer.
5. Tighten the coupling bolt with the specified torque (See Table-2).
6. Install the accessory cap rubber in the input shaft coupling wrench hole tap.

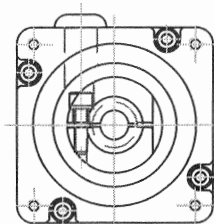

fig.1 No Keyway

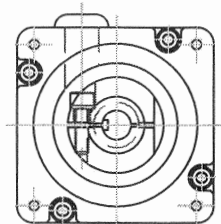

fig.2 With Keyway

※ Tightening torque for the flange bolt
Table-1(Reference Value)

Bolt Size	M3	M4	M5	M6	M8	M12
Tightening torque (N-m)	1.6	4.4	8.3	14.7	29.4	53.9

Note : M3~M8= Class 10.9 in the bolt strength category.

Note: M12 = Class 6.8 in the bolt strength category.

※ Tightening torque for Input Coupling Bolt
Table-2

Corresponding capacity	100W 200W 400W	750W	1000W 1500W 2000W 3000W
Bolt Size	M4	M5	M8
Tightening torque (N-m)	5.1	9	35

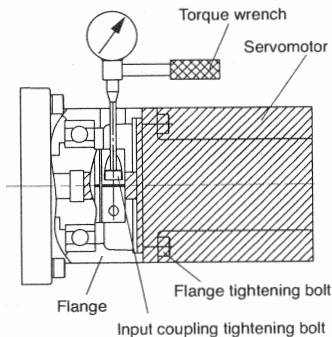

Wrench hole for tightening input coupling Cap (attachment of the unit)

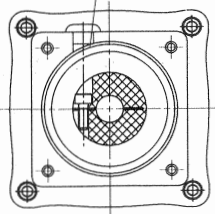

Do not tighten the coupling bolt while designated servomotor's output shaft is not inserted.

2-2 Installation of Reducer

a) Proper Environment for Installation

- ① Ambient Temperature: 0°C~40°C(Storage: -10°C~+60°C)
- ② Ambient Humidity: Less than 85%
- ③ Altitude: Less than 1,000m
- ④ Environment: Well ventilated place free from dust. In case of dangerous atmosphere such as explosive gas or vapor exist, be sure to use an explosion-proof motor.
- ⑤ Installation Location: Indoors

The surface temperature of the "A" in the figure should not exceed 90°C. In case the temperature goes over than 90°C, make it less than 90°C by cooling with an external fan or heat sink.

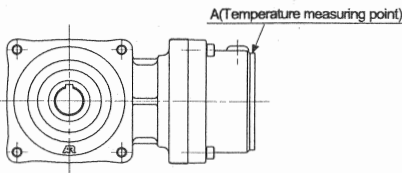

b) Method for Installation

- ① Install the product with the four bolts on a flat and machined surface free from vibration. In case the foundation is not sufficiently strengthened or the flatness of the installation surface is insufficient, vibration during operation may come out, which may shorten the reducer's life. (Flatness of the surface should be less than 0.1mm.)
- ② Fixing, Attaching and Removing of Hollow Shaft Type:

● Method of Fixing

A) In case the driven shaft has a shoulder:

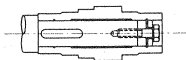

B) In case of no shoulder on the driven shaft:

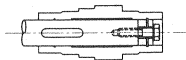

● Attaching and Removing of the driven shaft

Smooth attaching and removing can be obtained by following the instructive figure drawn below:

A) At attaching



B) At removing

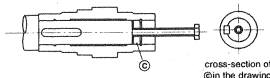

(Note) Before mounting, be sure to apply agent such as molybdenum disulfide on the driven shaft and the bore of the hollow shaft to avoid seizing. ("h7" is recommended as the tolerance for a driven shaft.)

③ Connection of the solid shaft

● For solid object

(Tightening with ball screw, etc.)

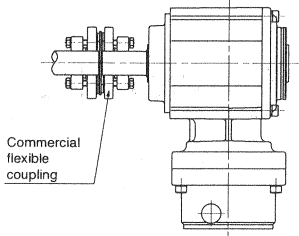

● For hollow object

(Tightening with pulley, etc.)

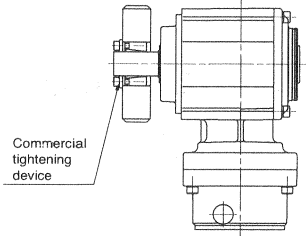

c) Mounting Position

This product can be mounted in any direction due to a grease lubrication system.

d) Connecting with Other Equipment

For connecting this machine to the other equipment, be sure to observe following points:

- "H7" fit is recommended for the couplings, sprockets, pulleys, gears, etc. when attaching to the reducer.

(1) Direct Connection

Connect the machine to the other equipment precisely, so that the center of the shaft of both machines will be fully aligned.

(2) Attaching Chains, Belt, Gears, etc.

- In any connection, connect the units precisely, so that the center of the shafts of the reducer and that of the other equipment are parallel. Also, be sure that the centerline of the sprockets and pulleys must be perpendicular to the shaft.
- In case excessive load is applied to the end of the output shaft, unexpected force could arise, which may result in crack of the case. Therefore, insert the sprockets, pulley, gear, etc. to the shoulder of the shaft, so that the load point could be as close to the reducer as possible.
- When operating by using belt, be sure not to give too much tension in order to avoid slipping. Excessive tensioning may result in damage to the bearings of the shaft.
- When operating by using chain, if the chain is installed loosely, shock load will occur when the drive shaft starts rotation, and this can result in damage to the reducer and the other equipment. Therefore, care should be given to the tension of the chain.

3 Rigidity

The Deviation of the following output shaft positions converted into angular unit is defined as the backlash of the unit.

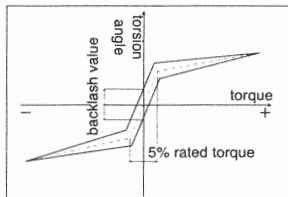

4 Maintenance and Product Life

All the models are filled with grease. Therefore the equipment can be used without supplying any additional lubricant.

The reducer is designed for use for the period of 10,000 hours as a target.

The life of an oil seal varies according to its operating condition. Some pieces may need change before 10,000 hours.

Accuracy(Backlash) also varies according to the operating condition.

5 Warranty

1 Warranty Term

The shorter term of 18 months after the delivery date or a time of 12 months of operation, shall be considered as the warranty period.

2 Scope of Warranty

- (1) Warranty shall be limited to the products manufactured in our factory.
- (2) If a fault or defect of the product, i.e. proper function cannot be obtained, is found during above period under appropriate operating condition after proper installation, connection and handling (inspection and maintenance) specified in the instruction manual, the repair shall be free of charge. However, in case a fault or defect is applicable to the escape clause listed below, above treatment will not be applied.

3 Escape Clause

- 1) Repair, change or replacements for the damages caused by customer's arbitrary disassembly or modification.
 - 2) Deviation from normal operating condition under the rated data specified in this catalogue or under the specifications mutually agreed.
 - 3) Defect on the power transmission device (centering of coupling, etc.) between our machine and customer's equipment.
 - 4) Defects by Force Majeure like disaster (Earthquake, Thunderstorm, Fire, Flood, etc.) or customer's mistreatment.
 - 5) Subsidiary breakdown due to the failure of customer's equipment.
 - 6) Breakdown due to the fault of nominated parts or drive unit (motor, servomotor, hydraulic motor, etc.) provided by the customer.
 - 7) Improper storage, maintenance and handling.
 - 8) Problems which are not covered by product liability, except for above items.
 - 9) We are not responsible for the compensation against the loss of shutdown and/or for the damage to the equipments which are not produced by us, caused by the interruption of operation of our product.
- The items stipulated above are premised to apply to the transactions and uses in domestic Japan. In case of the operations in the other countries, all the conditions are settled by the prior discussion between customer and our Sales Department.

NISSEI CORPORATION

Sales, Overseas Division

1-1 Inoue, Izumi-cho, Anjo-shi, Aichi, 444-1297 JAPAN

TEL: +81-566-925312 FAX: +81-566-92-7002